

65101-11750
N300589

Installation Instructions

Honeycomb Shades Motorization

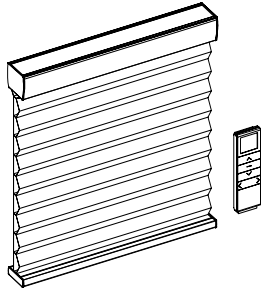

Getting Started

Remove shade from package. Save packaging until shade is installed and working to your satisfaction.

Tools:

- Level
- Measuring Tape
- Pencil
- Power drill (6mm hex driver and drill bit)
- Screwdriver



You will need to use the following fasteners for your particular mounting surface.

Surface	Fastener
Wood	Screws (Provide)
Drywall/Plaster	Wall Anchors, Expansion Bolts (Not Provide)
Metal	Sheet Metal Screws (Not Provide)

Check Component/Hardware:

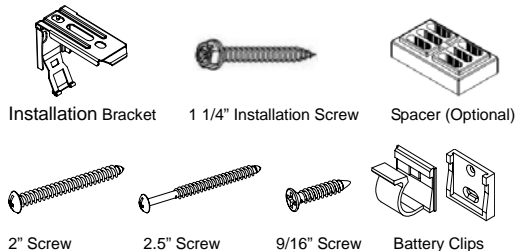

Hardware Standard Quantity

Order Width (X)	X 56"	56" < X 105"	X>105"
Installation Bracket	2	3	4
Spacer Block (Optional)	2	3	4
1 1/4" Screw (for Installation Bracket)	4	6	8
2" Screw (for Installation Bracket with 1~2pcs spacer block)	4	6	8
2.5" screw (for Installation Bracket with 4pcs spacer block)	4	6	8

Note: Optional flat head screws included. Use as needed.

Step 1: Bracket Installation

- Measure 1 9/16" (40mm) from both ends of the head rail. Mark the bracket location on the mounting surface. Proper alignment of brackets will make installation easier.
- When shade width is less than 24", the distance from both ends of the headrail is 1 3/16" (30mm).

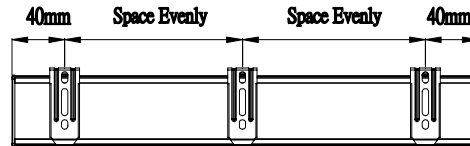

Inside Mount

- Align the front of brackets 1/16" to the edge of window opening.
- Use two 1 1/4" installation screws to secure brackets. Use wall anchors for drywall or plaster wall.

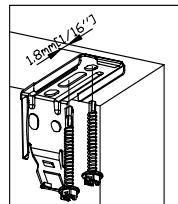

Outside Mount

- Align the bottom of brackets with the top window frame as right picture.
- Use two 1 1/4" installation screws to secure brackets. Use wall anchors for drywall or plaster wall.

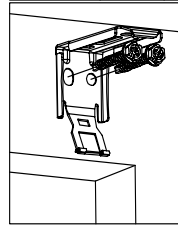

Note: If spacer block is required, please follow the following guide:

Please always make sure the raised side of the spacer block is against the bracket. Use 2" screws for one or two pcs of spacers, and 2.5" screws for 4 pcs of spacers. See picture below:

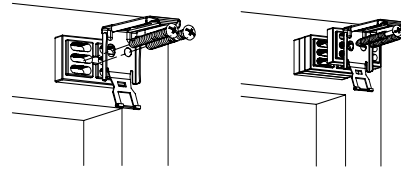

Step 2: Install Battery Clip

A: Battery wand behind the head rail

Screw mounting plates for the battery clip into pre-drilled holes on the back of the head rail. Use one 9/16" screw for each mounting plate.

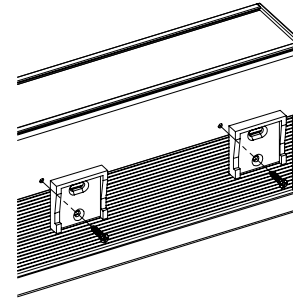

Slide the battery clip onto the mounting plate.

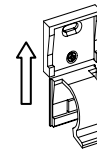

B: Battery wand outside the window opening

Position the mounting plate and make sure the plug for the battery wand and motor can be connected.

Install the mounting plates 4 7/16" in between as shown. Use two 9/16" screws fix the mounting plate and then slide the battery clip onto the mounting plate.

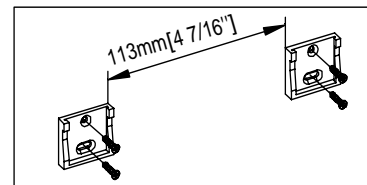

Step 3: Install the Battery Wand

Unscrew the end cap of the battery wand and load 8 AA batteries (not provided) according to the sign symbol on the battery wand. Then clip the battery wand to the battery clips.

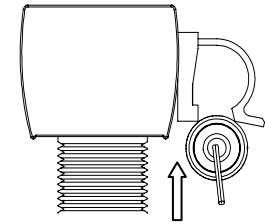

Step 4: Install the Shade

- Position head rail at an angle so that it is hooked to the front of the bracket. Then push it upward at the back to snap into the bracket.

⚠ For proper installation, start with attaching the front of the headrail to the bracket.

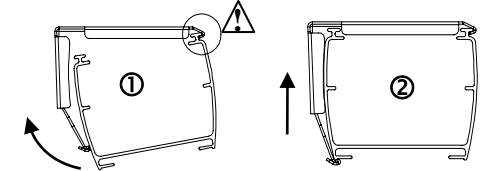

Step 5: Install Remote Control Holder (Optional)

Position the remote control holder with two 9/16" screws and the distance between screws is 3 1/4" and screws protrude 1/8". Attach the remote control holder to the screw.

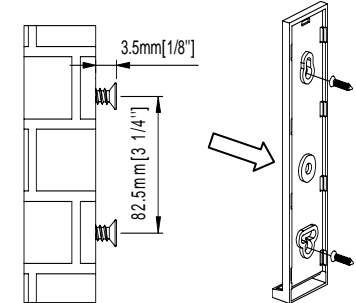

Shade Operation

Connect the battery wand or AC/DC adapter to the motor.

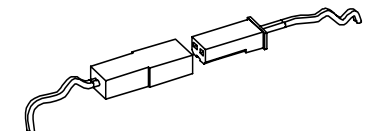

Install remote battery and make sure the screen shows the right channel for the shade, and then the shade can be operable. Please refer to the remote instructions for adjustment.

Note: Channel 1 is the default shown on the remote screen and channel 0 controls all shades programmed in one remote.

Remove the Shade

Fully raise the shade, and then gently pry the bracket off the head rail with a flat screwdriver. Remove the shade.

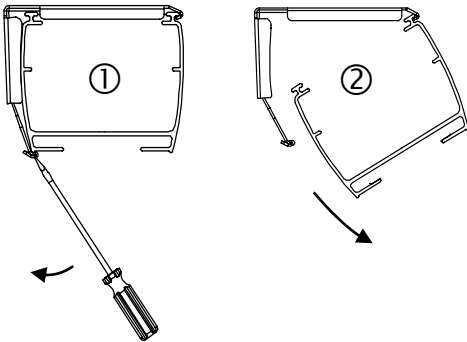

Replacing Batteries

Disengage the battery wand by pushing the clip upward. Reload new batteries.

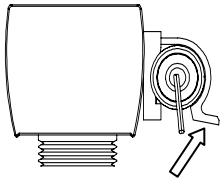

Manual Control Button

When remote is not available, the shade can be operated by the manual control button.

⚠ Do not continue to press the manual control button over 4secs.

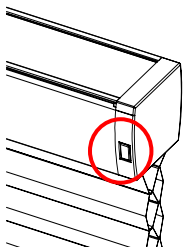

Replacing Motor

1. Lower the bottom rail about 50mm and disconnect wires, then remove the shade from the brackets.
2. Pull out the end cap.

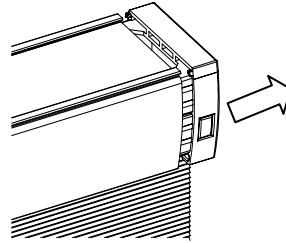

3. Pull out the cover to the non-motor side and slide the motor out of the headrail.

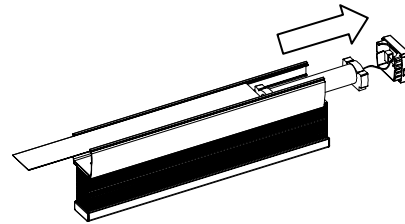

4. Push the new motor back to the headrail and make sure the shaft align with the power output hole of the motor.

5. Put the wire which is for connecting motor and manual control button to the side away the manual control button.

6. Slide the cover to the original position and install the end caps.

Cleaning the Shade

Routine cleaning will help maintain the beauty of your shade. The shade can be cleaned by using a soft brush, vacuumed with a low suction hand-held vacuum, cleaned ultrasonically (specify that a mild solution must be used and that the head rail should never be immersed in liquid), or dampen a clean cloth with a warm water and mild detergent solution to dab the spot until it's gone (do not rub!).

⚠ Do not spray the liquid to the electric parts of the motorized shade.